

# 高雄巨蛋附屬空間簡介

---

平面配置規劃資料-紅區西南



行銷企劃 2011/02/14

# 高雄巨蛋選租空間

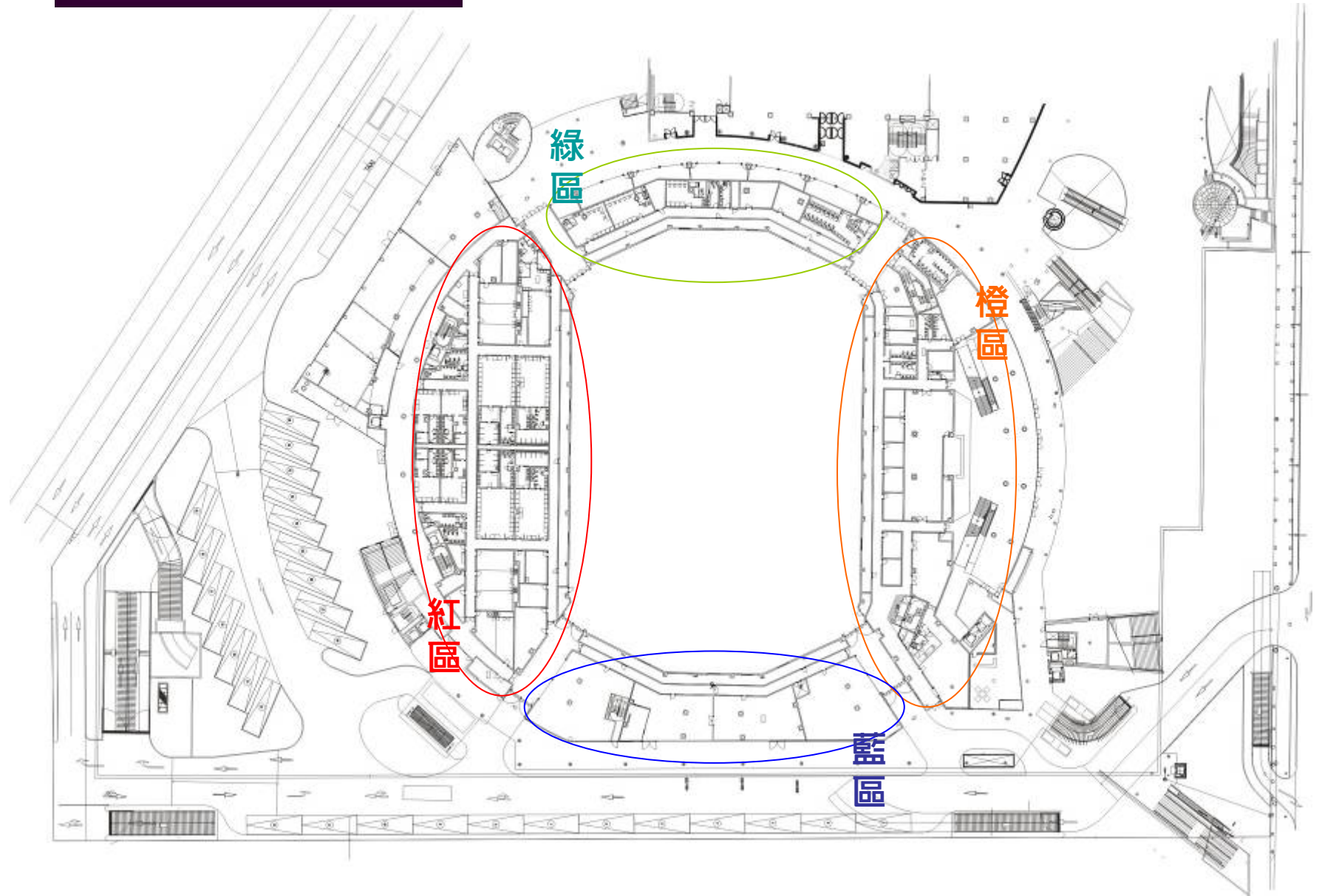

# 高雄巨蛋紅區全圖



# 高雄巨蛋紅區西南



# Red Area 1-61



空間編號	坪數	空間說明
1-61 貴賓室	20.9坪	批土,面刷水性水泥漆 地坪/ 6.5mm方塊地毯 電話/網路出線盒*2 無線路由器*2 指針式子鐘*1 TV出口 125V雙聯暗插座*3 馬達出線口*1 FAN COIL出線口*2 1迴路

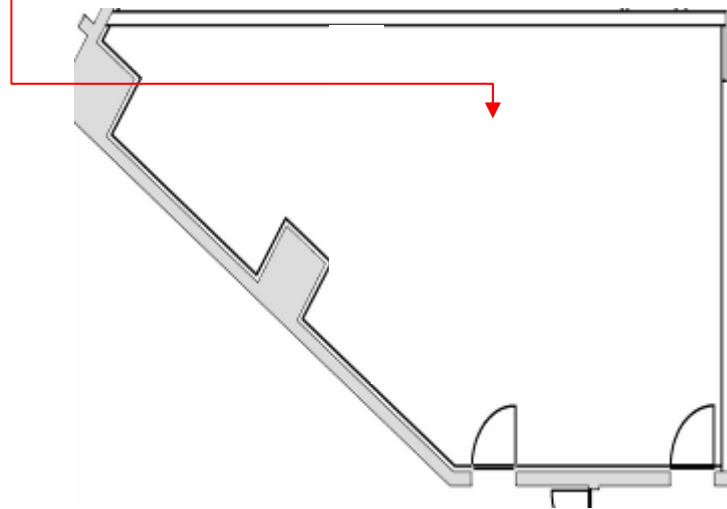

## 空間說明



# Red Area 1-60

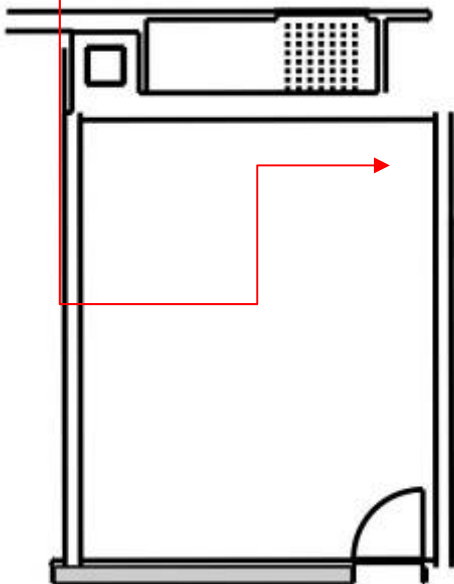

空間編號	坪數	空間說明
1-60 休息室	8.49坪	125V雙聯暗插座*2 茶水間專用插頭*1 無線路由器*1 指針式子鐘*1 TV出口 地坪/無縫塑膠地板 批土,面刷水性水泥漆



# Red Area 1-58

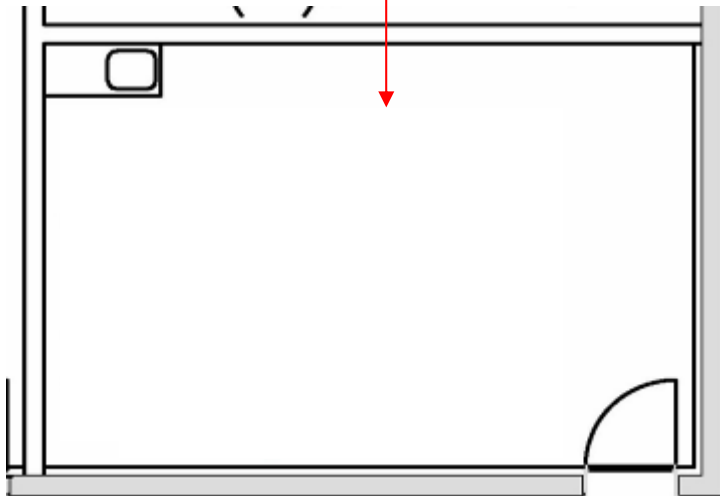
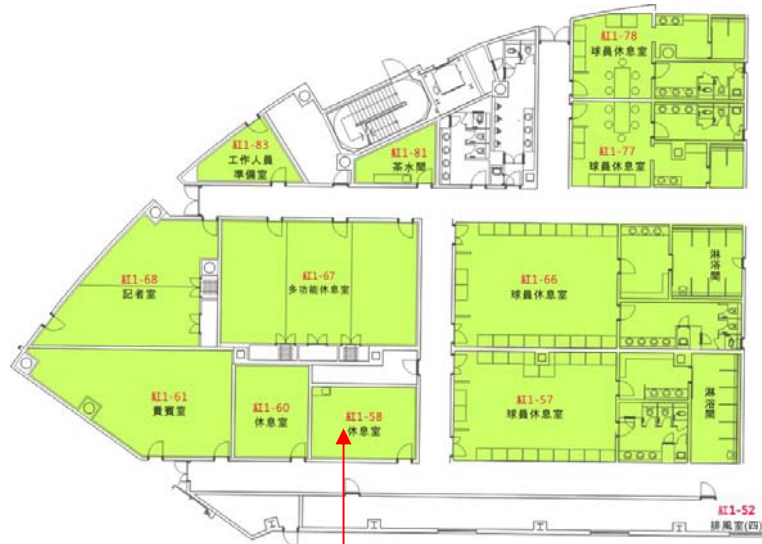

空間編號	坪數	空間說明
1-58 休息室	9.28坪	125V雙聯暗插座*3 馬達出線口*1 FAN COIL出線口*1 1迴路電話/網路出線盒*2 指針式子鐘*1 TV出口 地坪/無縫塑膠地板 批土,面刷水性水泥漆



# Red Area 1-57

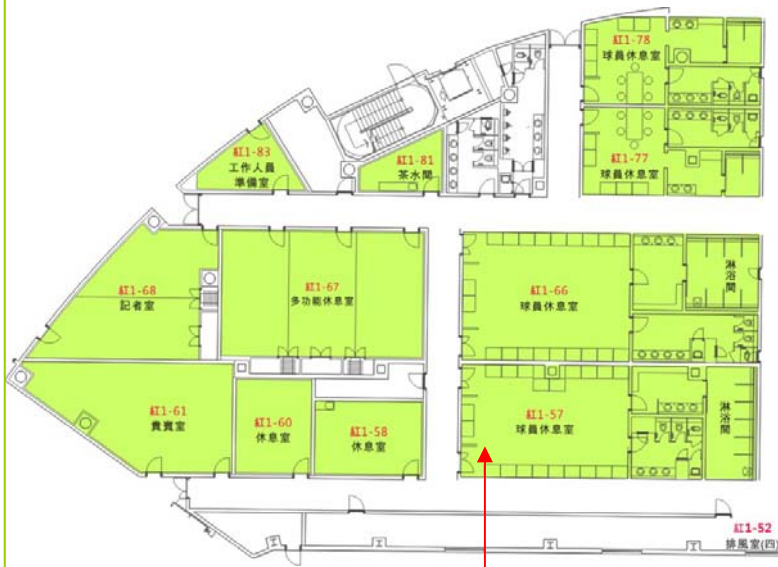

空間編號	坪數	空間說明
1-57 球員休息室 廁所(七) 化妝室(七) 淋浴間(七)	22.26坪 4.38 3.8 6.86	<p>125V雙聯暗插座*3 FAN COIL出線口*2電話/網路出線盒*2 數位式子鐘*1無縫塑膠地板 批土,面刷水性水泥漆</p> <p><u>廁所</u> 手機專用插*1 地坪/瓷質地磚化妝矽酸鈣板 190cm以上批土,面刷乳膠漆</p> <p><u>化妝室</u> 無縫塑膠地板 批土,面刷PVC塑膠漆</p> <p><u>淋浴間</u> 20*20cm止滑石英磚 20*20cm石英磚</p>

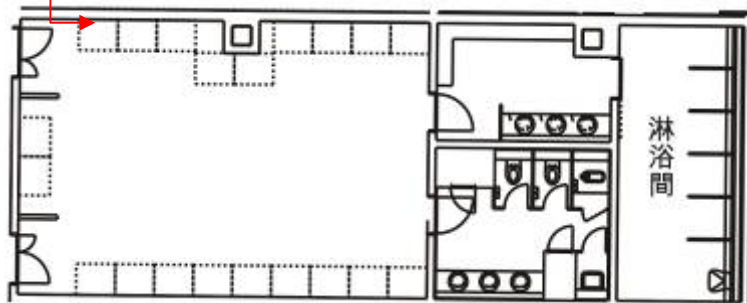

## 空間說明





# Red Area 1-66

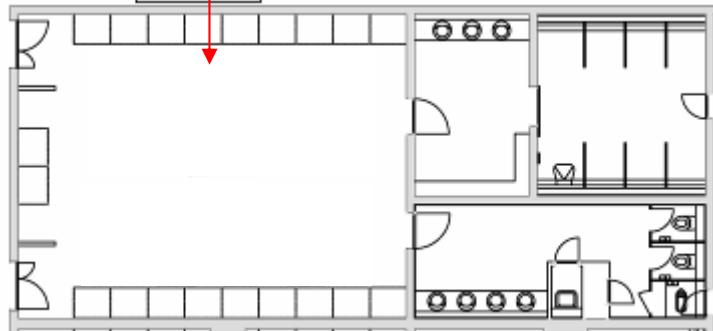

空間編號	坪數	空間說明
1-66 球員休息室 球員休息室 廁所(七) 化妝室(七) 淋浴間(七)	25.56坪 7.05坪 4.55坪 6.65坪	<p>125V雙聯暗插座*3 FAN COIL出線口*3電話/網路 出線盒*2 數位式子鐘*1無縫塑膠地板批 土,面刷水性水泥漆</p> <p><u>廁所</u> 手機專用插*1 地坪/瓷質地磚化妝矽酸鈣板 190cm以上批土,面刷乳膠漆</p> <p><u>化妝室</u> 無縫塑膠地板 批土,面刷PVC塑膠漆</p> <p><u>淋浴間</u> 20*20cm止滑石英磚 20*20cm石英磚</p>

## 空間說明



# Red Area 1-67

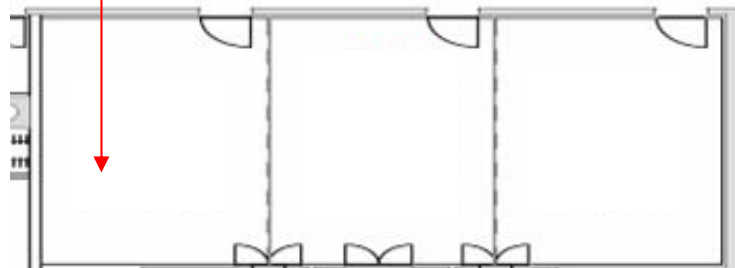

空間編號	坪數	空間說明
1-67 多功能休息室	30.1坪	125V雙聯暗插座*6 FAN COIL出線口*2 茶水間專用插頭*3 2迴路電話/網路出線盒*3 無線路由器*2 指針式子鐘*1 TV出口 地坪/無縫塑膠地板 批土,面刷水性水泥漆

## 空間說明



# Red Area 1-68

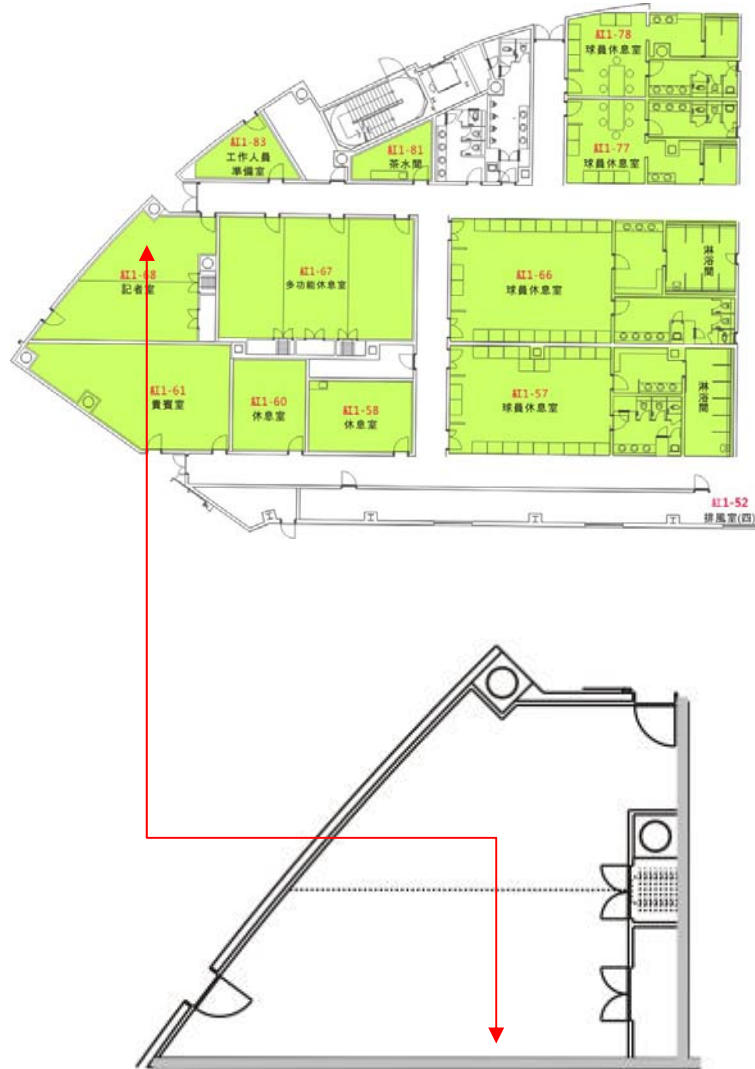

空間編號	坪數	空間說明
1-68 記者室	19.49坪	125V雙聯暗插座*5 FAN COIL出線口*2 茶水間專用插頭*2電話/網路出線盒*2 無線路由器*2 指針式子鐘*1 TV出口 地坪/無縫塑膠地板 批土,面刷水性水泥漆



# Red Area 1-77

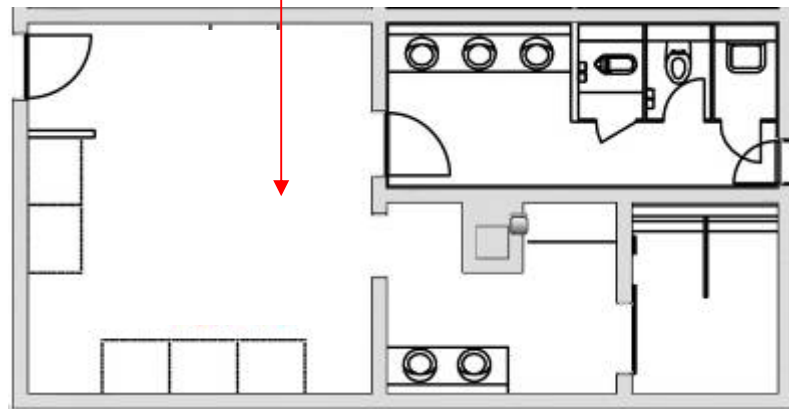

空間編號	坪數	空間說明
1-77 球員休息室	8.49坪 4.17坪 2.68坪 1.88坪	<p>125V雙聯暗插座*1 FAN COIL出線口*2電話/網路出線盒*1 數位式子鐘*1無縫塑膠地板批土,面刷水性水泥漆</p> <p><b>廁所</b> 手機專用插*1 瓷質地磚化妝矽酸鈣板 190cm以上批土,面刷乳膠漆</p> <p><b>化妝室</b> 地坪/無縫塑膠地板 批土,面刷PVC塑膠漆</p> <p><b>淋浴間</b> 20*20cm止滑石英磚 20*20cm石英磚</p>

## 空間說明



# Red Area 1-78

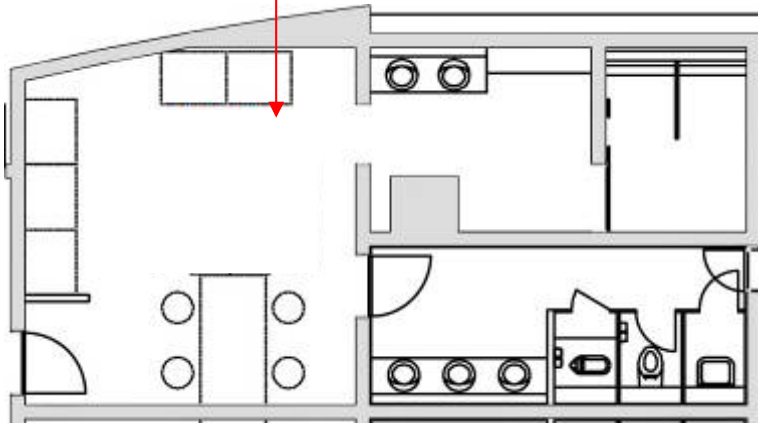
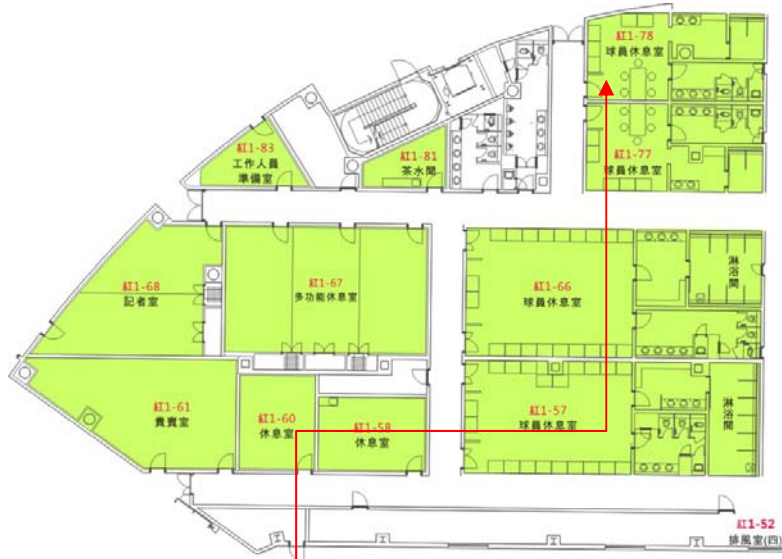

空間編號	坪數	空間說明
1-78 球員休息室 廁所(七) 化妝室(七) 淋浴間(七)	8.28坪 4.17坪 2.68坪 1.88坪	125V雙聯暗插座*1 FAN COIL出線口*2電話/網路出線盒*1 數位式子鐘*1無縫塑膠地板批土,面刷水性水泥漆 <u>廁所</u> 手機專用插*1 瓷質地磚化妝矽酸鈣板 190cm以上批土,面刷乳膠漆 <u>化妝室</u> 地坪/無縫塑膠地板 批土,面刷PVC塑膠漆 <u>淋浴間</u> 地坪/ 20*20cm止滑石英磚 20*20cm石英磚

## 空間說明



# Red Area 1-81

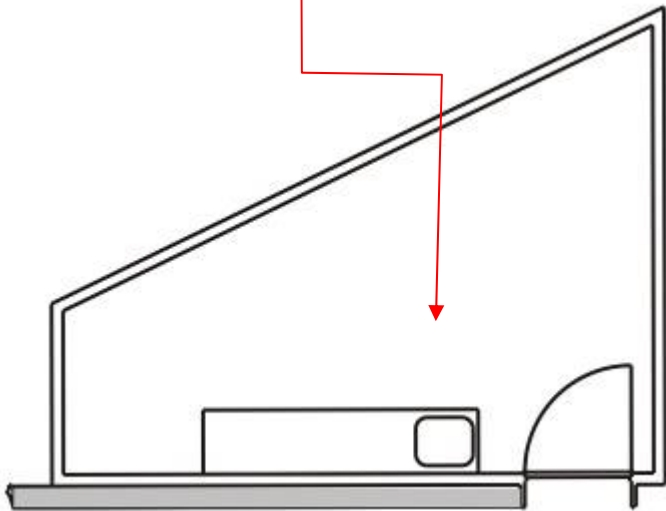

空間編號	坪數	空間說明
1-81 茶水間	4.15坪	125V雙聯暗插座*2 1迴路電話/網路出線盒*1 指針式子鐘*1 地坪/環氧樹脂耐磨地坪 批土,面刷PVC塑膠漆



# Red Area 1-83

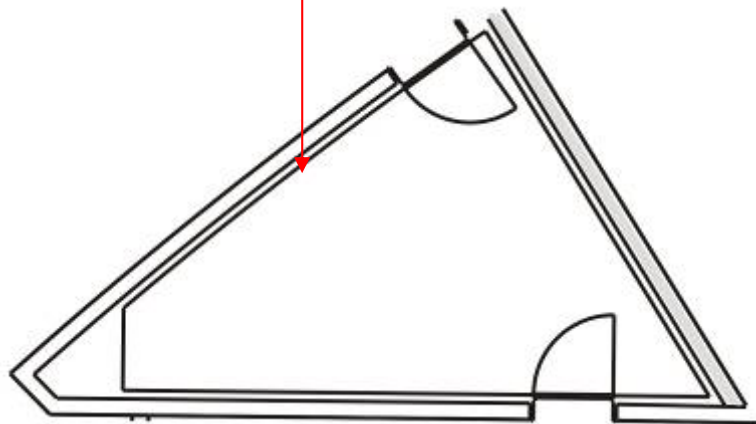

空間編號	坪數	空間說明
1-83 工作人員準備室	4.98坪	125V雙聯暗插座*2 FAN COIL出線口*1 茶水間專用插頭*1電話/網路出線盒*1 指針式子鐘*1 TV出口 地坪/無縫塑膠地板 批土,面刷水性水泥漆

## 空間說明

