

# 高雄巨蛋附屬空間簡介

---

平面配置規劃資料-橙區

行銷企劃 2011/02/14

# 高雄巨蛋選租空間

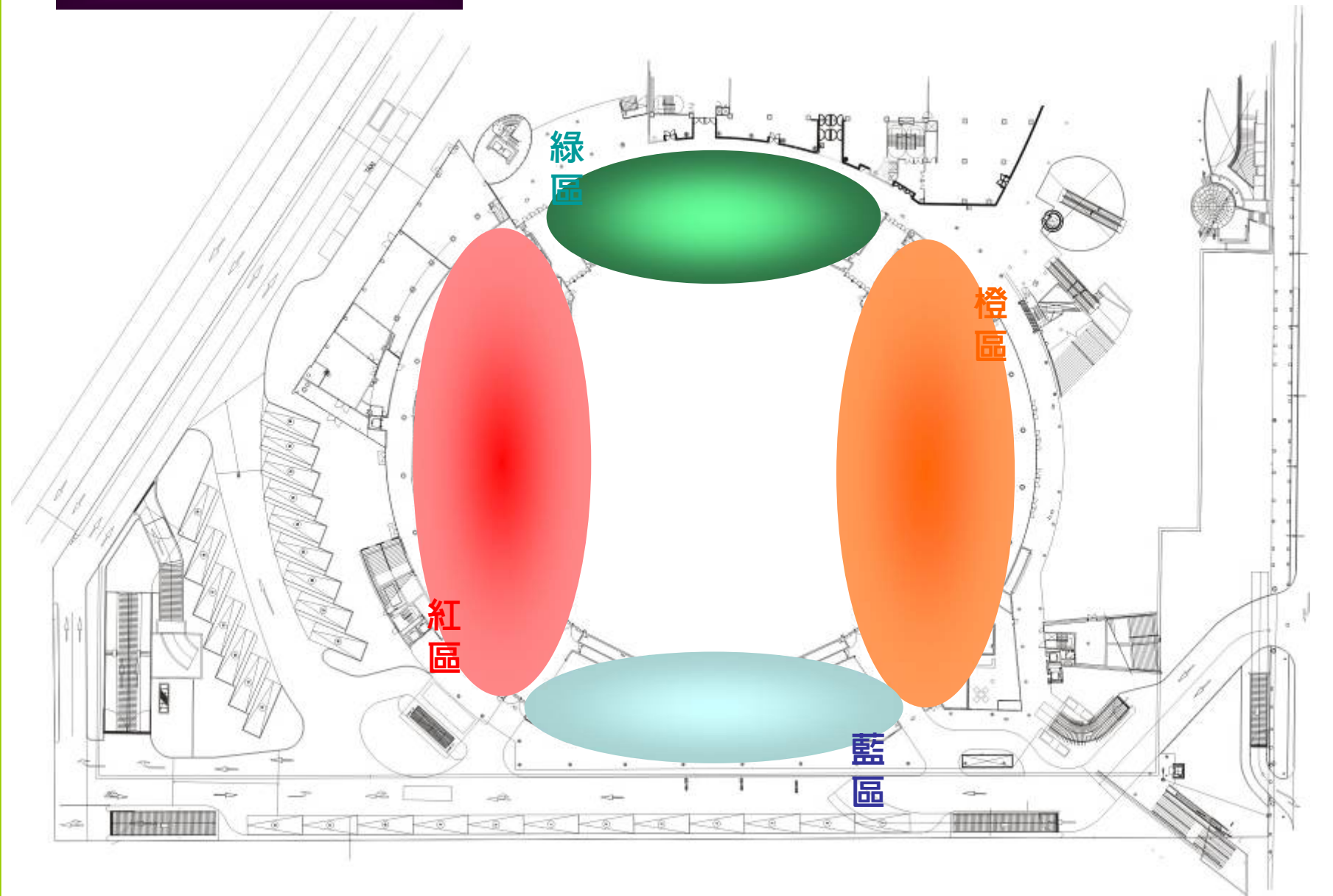

# 高雄巨蛋橙區全圖

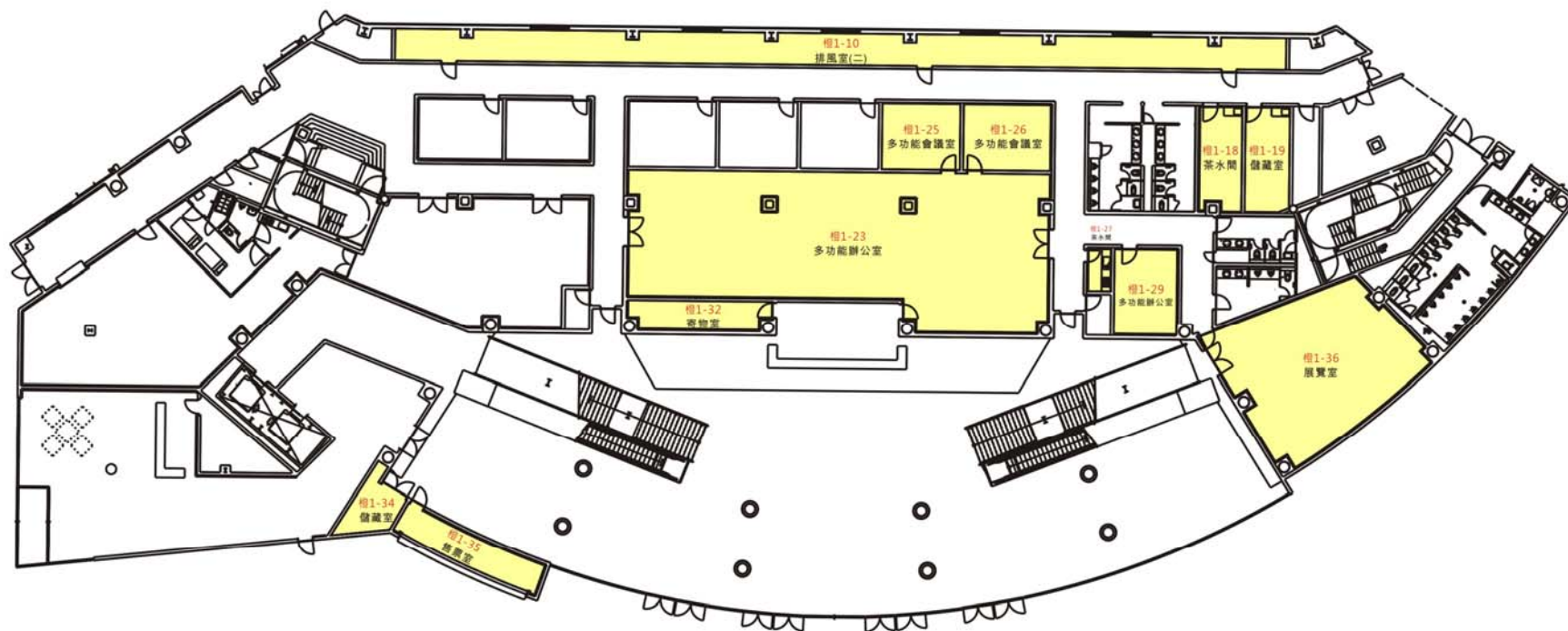

# Orange Area 1-32 Service Counter

空間編號	坪數	空間說明
1-32 寄物室	4.95 坪	125V隱藏式雙聯地板插座*2 電話/網路出線盒*2無縫塑膠 地板批土,面刷水性水泥漆
東大廳 服務台	9坪	125V雙聯暗插座*4 125V隱藏式雙聯地板插座*3 2迴路電話/網路出線盒*2光面 花崗石石膏板貼玻纖底布 批土,面刷乳膠漆

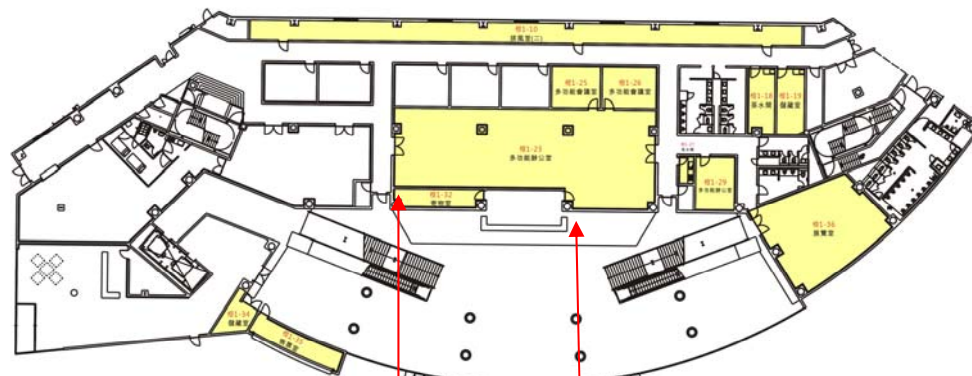

## 空間說明

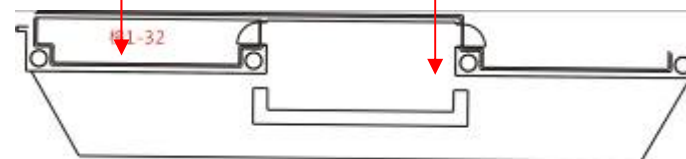

# Orange Area - East Hall

空間編號	坪數	空間說明
1F 貴賓入口大廳	47坪	125V雙聯暗插座*6 1迴路 馬達出線口*1 數位式子鐘*1 光面花崗石 乾式懸掛2.5cm光面 花崗岩

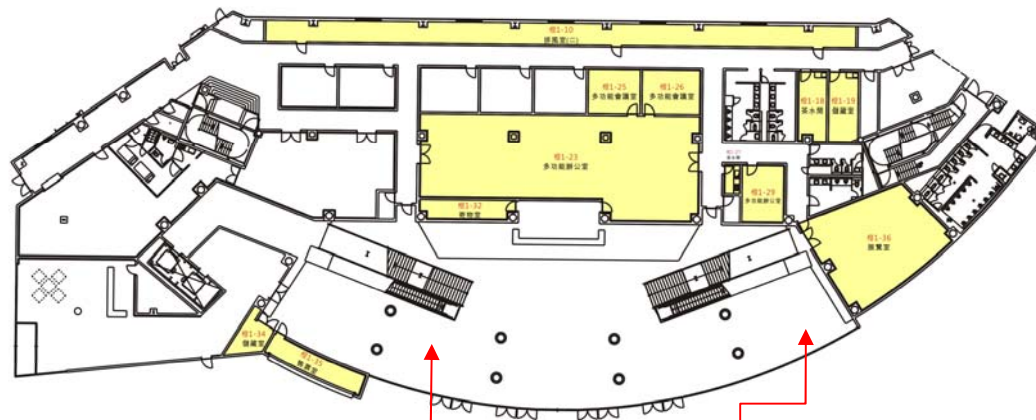

## 空間說明

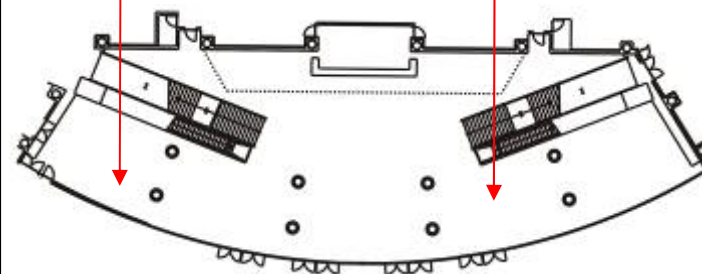



# Orange Area 1-35

空間編號	坪數	空間說明
1-35 售票室	5.89坪	125V雙聯暗插座*12 3迴路電話/網路出線 盒*2 指針式子鐘*1 地評/無縫塑膠地板 批土,面刷水性水泥漆

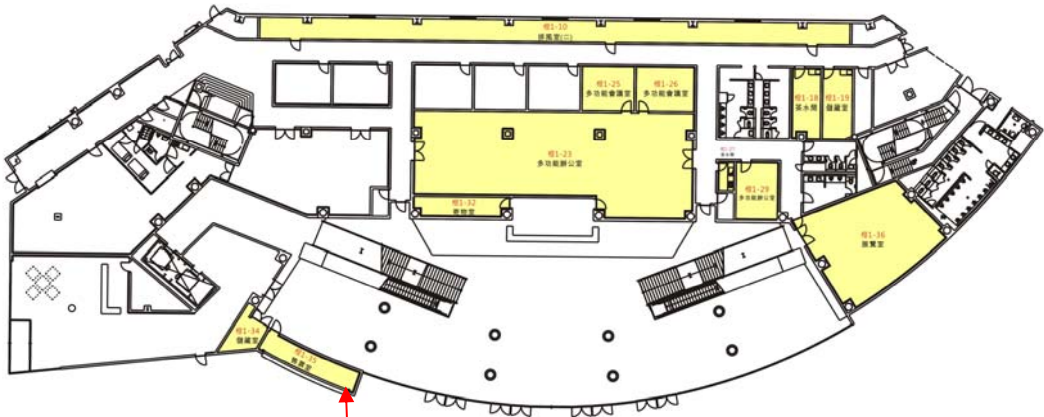

## 空間說明

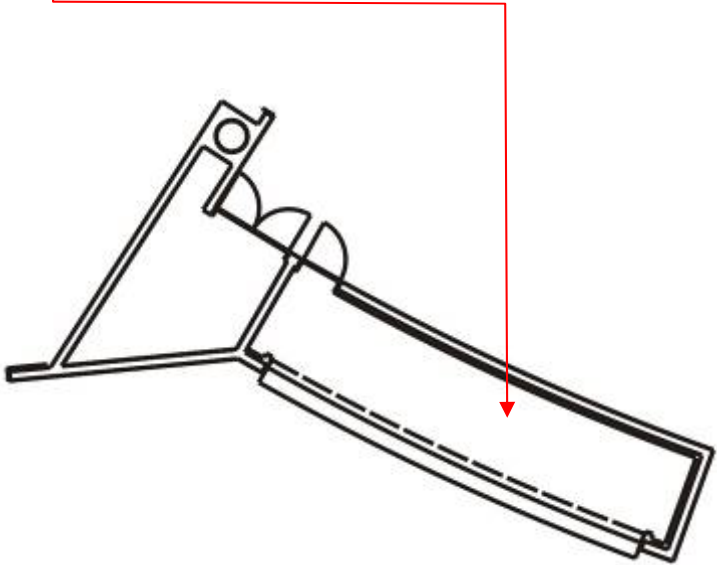

# Orange Area 1-36

空間編號	坪數	空間說明
1-36 記者室	30.89坪	125V雙聯暗插座*8 茶水間專用插座*4 3迴路 電話/網路出線盒*2 無線路由器*2 指針式子鐘*1TV出口 無縫塑膠地板 批土,面刷PVC塑膠漆

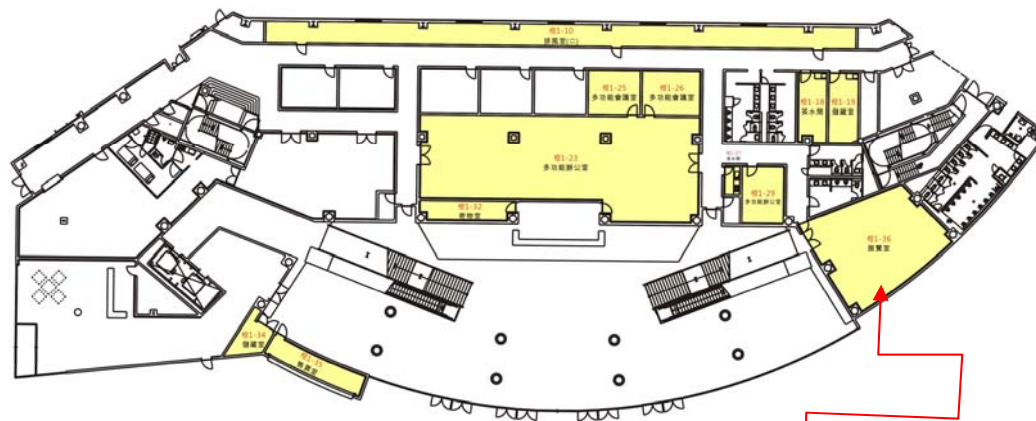

## 空間說明

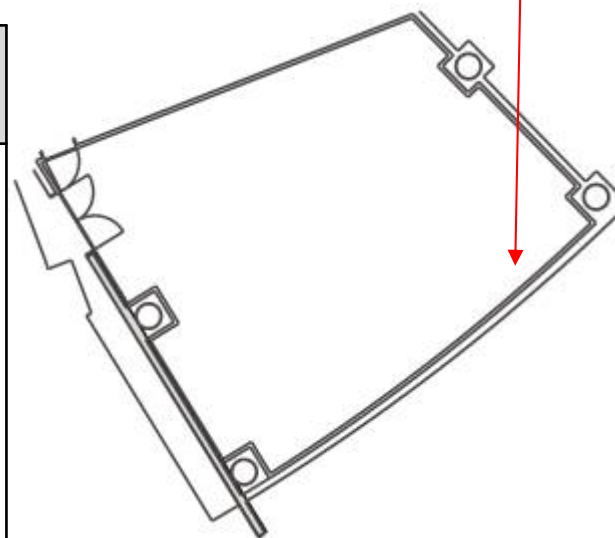

# Orange Area 1-29

空間編號	坪數	空間說明
1-29 記者室	6.76坪	125V雙聯暗插座*3 茶水間專用插座*1 1迴路 電話/網路出線盒*2 指針式子鐘*1 TV出口 無縫塑膠地板 批土,面刷PVC塑膠漆

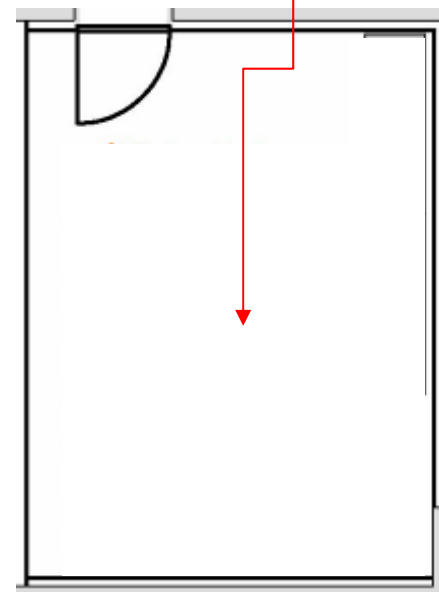
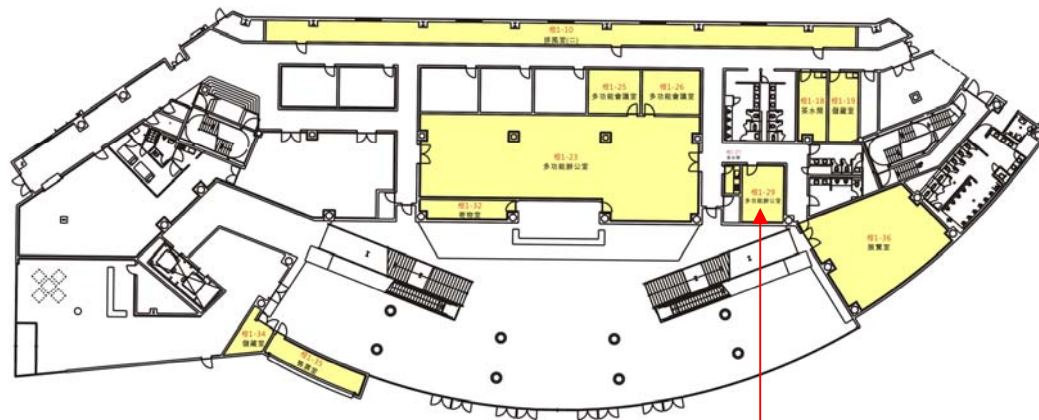



# Orange Area 1-27

空間編號	坪數	空間說明
1-27 茶水間	4.98	125V雙聯暗插座*2 茶水間專用插頭*1 1迴路電話/網路出線 盒*1 無線路由器*1 數位式子鐘 TV出口 地坪/無縫塑膠地板 批土,面刷水性水泥漆

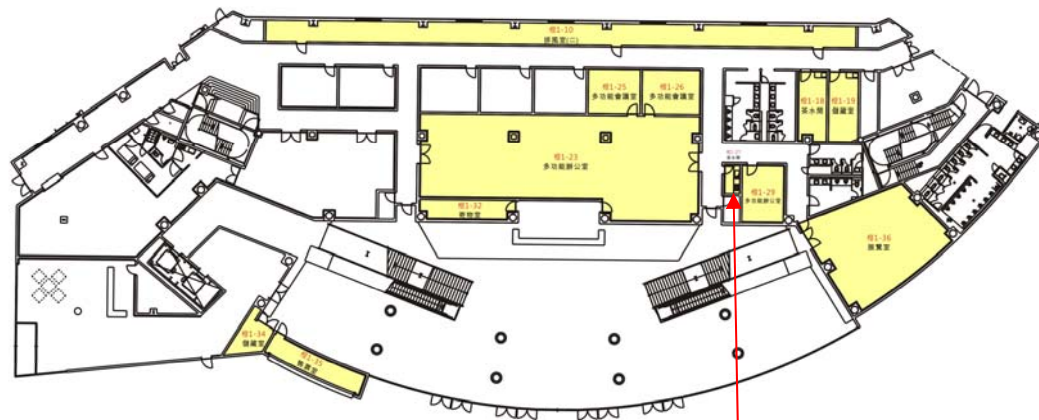

空間說明

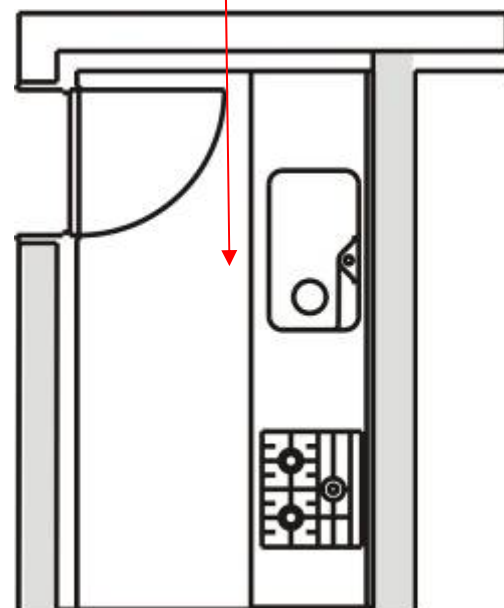

# Orange Area 1-18 1-19

空間編號	坪數	空間說明
1-18 茶水間	5.86坪	125V雙聯暗插座*2 電話/網路出線盒*1 指針式子鐘*1 無縫塑膠地板 批土,面刷水性水泥漆
1-19 儲藏室	5.35坪	125V雙聯暗插座*2 電話/網路出線盒*1 指針式子鐘*1 無縫塑膠地板 批土,面刷水性水泥漆

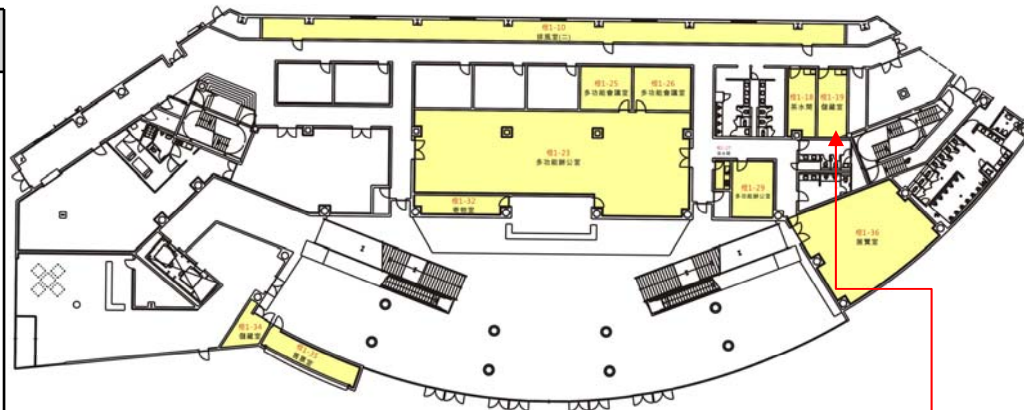

## 空間說明

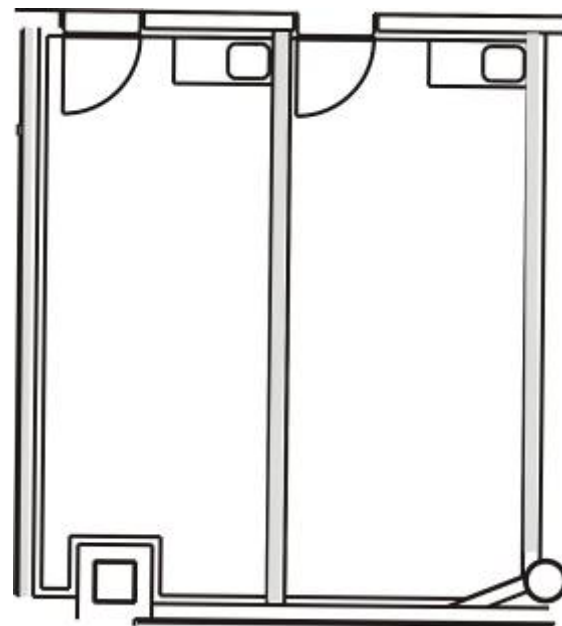

# Orange Area 1-23

空間編號	坪數	空間說明
1-23 多功能辦公室	73坪	125V隱藏式雙聯地板 插座*34 9迴路 125V雙聯暗插座*2 電話/網路出線盒*34 指針式子鐘*2 TV出口*2 無縫塑膠地板 批土,面刷水性水泥漆

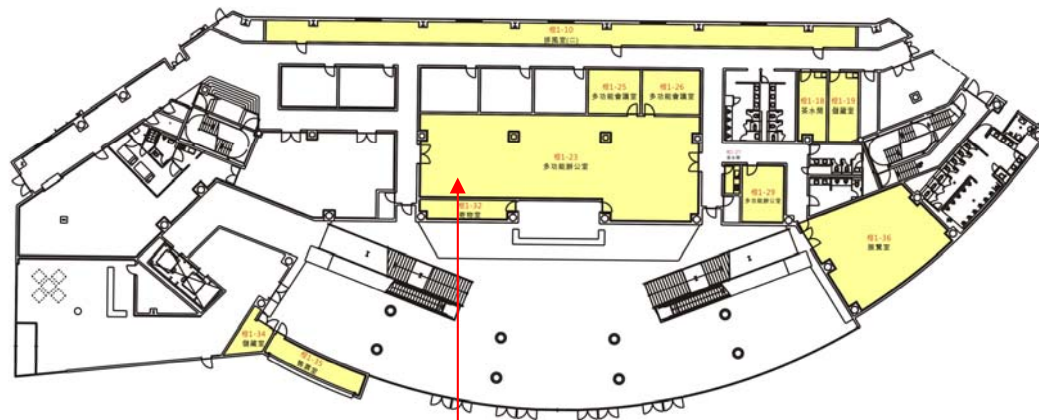

## 空間說明

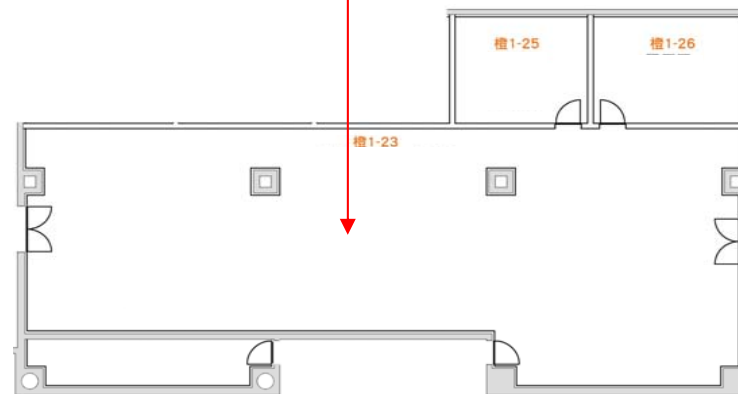

# Orange Area 1-25 1-26

空間編號	坪數	空間說明
1-25 多功能會議室	6.52坪	125V雙聯暗插座*3 電話/網路出線盒*1 數位式子鐘*1 TV出口無縫塑膠地板 批土,面刷水性水泥漆
1-26 多功能會議室	7.25坪	125V雙聯暗插座*3 電話/網路出線盒*1 數位式子鐘*1 TV出口 無縫塑膠地板批土,面 刷水性水泥漆

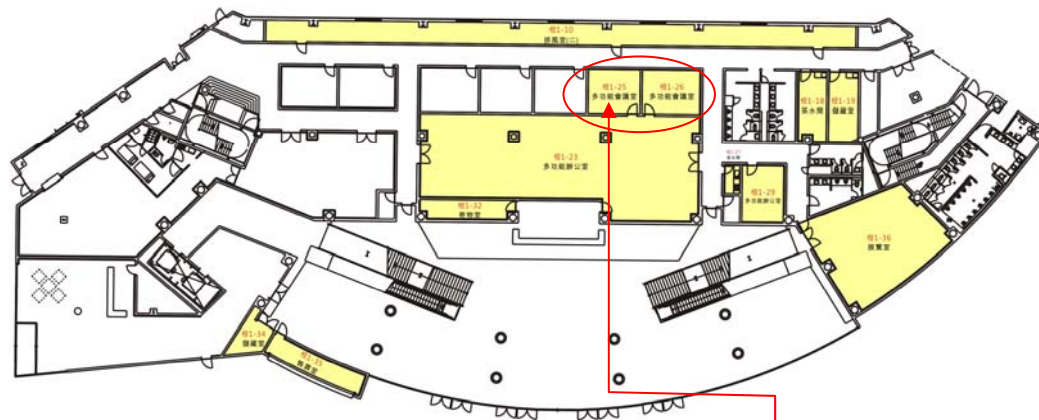

## 空間說明

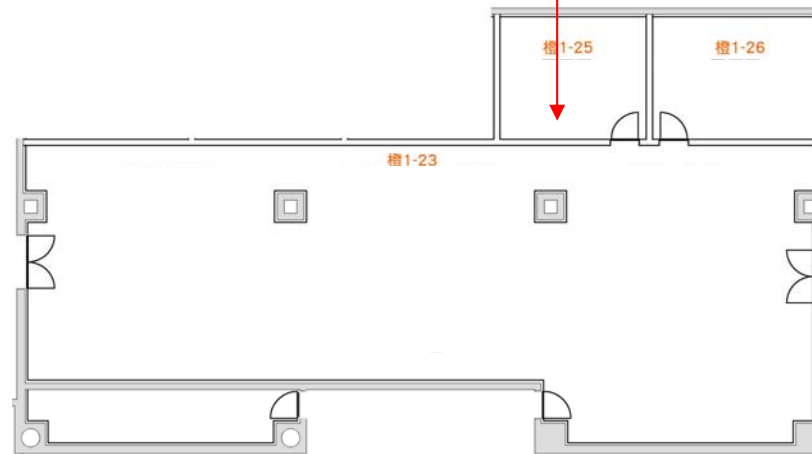

# Orange Area 1-11 1-12 1-13

空間編號	坪數	空間說明
1-11 會議室	6.45坪	<u>1-11 1-12</u> 125V雙聯暗插座*2 電話/網路出線盒*2 指針式子鐘*1 6.5mm方塊地毯輕隔間 面貼防焰壁紙
1-12 會議室	6.45坪	<u>1-13</u> 125V雙聯暗插座*4 1迴路電話/網路出線盒*1 指針式子鐘*1 TV出口6.5mm方塊地毯 輕隔間面貼防焰壁紙
1-13 貴賓招待室	7.25坪	

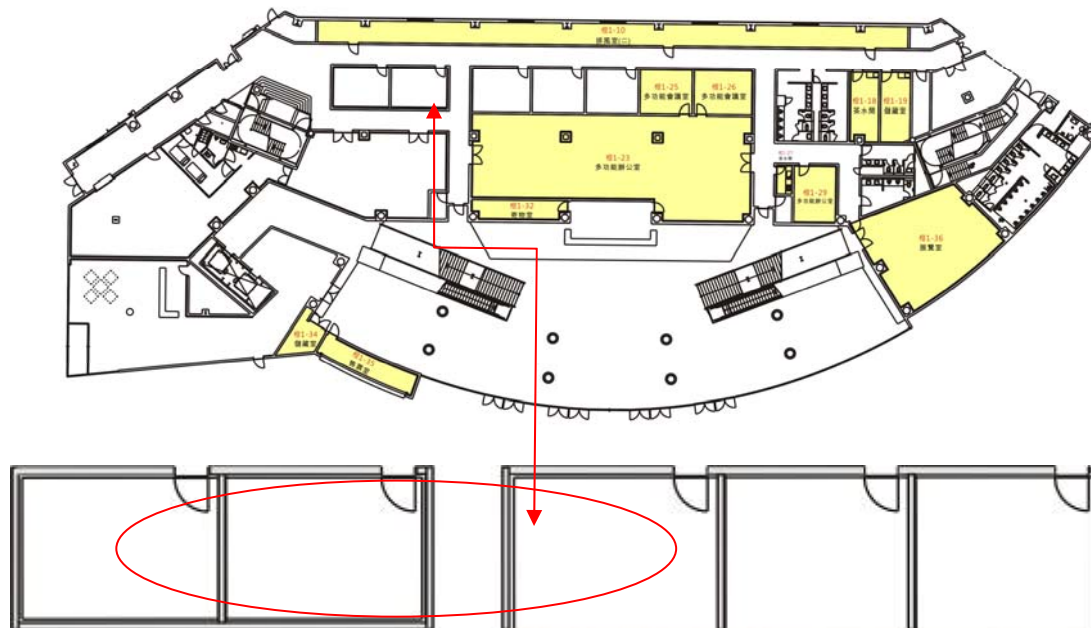

## 空間說明

